

Compact Disc MiniDisc Deck

Operating Instructions



MDLP

MXD-D400

WARNING

To prevent fire or shock hazard, do not expose the unit to rain or moisture.

To prevent fire, do not cover the ventilation of the apparatus with news papers, table-cloths, curtains, etc. And don't place lighted candles on the apparatus.

To prevent fire or shock hazard, do not place objects filled with liquids, such as vases, on the apparatus

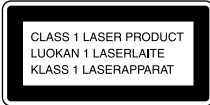

This appliance is classified as a CLASS 1 LASER product. This label is located on the rear exterior.

The following caution label is located inside the apparatus.



Don't throw away the battery with general house waste, dispose of it correctly as chemical waste.

For the customer in the U.S.A.

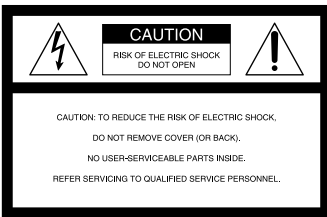

This symbol is intended to alert the user to the presence of uninsulated "dangerous voltage" within the product's enclosure that may be of sufficient magnitude to constitute a risk of electric shock to persons.



This symbol is intended to alert the user to the presence of important operating and maintenance (servicing) instructions in the literature accompanying the appliance.

Owner's Record

The model and serial numbers are located on the rear of the unit. Record the serial number in the space provided below. Refer to them whenever you call upon your Sony dealer regarding this product.

Model No. MXD-D400 Seral No. _____

Caution

The use of optical instruments with this product will increase eye hazard.

WARNING

This equipment has been tested and found to comply with the limits for a Class B digital device, pursuant to Part 15 of the FCC Rules. These limits are designed to provide reasonable protection against harmful interference in a residential installation. This equipment generates, uses, and can radiate radio frequency energy and, if not installed and used in accordance with the instructions, may cause harmful interference to radio communications. However, there is no guarantee that interference will not occur in a particular installation. If this equipment does cause harmful interference to radio or television reception, which can be determined by turning the equipment off and on, the user is encouraged to try to correct the interference by one or more of the following measures:

- Reorient or relocate the receiving antenna.
- Increase the separation between the equipment and receiver.
- Connect the equipment into an outlet on a circuit different from that to which the receiver is connected.
- Consult the dealer or an experienced radio/TV technician for help.

CAUTION

You are cautioned that any changes or modifications not expressly approved in this manual could void your authority to operate this equipment.

IN NO EVENT SHALL SELLER BE LIABLE FOR ANY DIRECT, INCIDENTAL OR CONSEQUENTIAL DAMAGES OF ANY NATURE, OR LOSSES OR EXPENSES RESULTING FROM ANY DEFECTIVE PRODUCT OR THE USE OF ANY PRODUCT.

Except for European model



ENERGY STAR® is a U.S. registered mark. As an ENERGY STAR® partner, Sony Corporation has determined that this product meets the ENERGY STAR® guidelines for energy efficiency.

Table of Contents

How to use this manual.....	4	Adjusting the recording level	25
Playable discs.....	4	— Music Synchro-Recording	
<hr/>			
Getting Started		Recording the current CD track.....	27
Unpacking	7	— REC-IT Function	
Hooking up.....	7	Synchro-Recording with an external audio equipment	27
<hr/>			
CD/MP3/MD – Play		Fading in and out	28
Loading a CD.....	9	— Fader	
Playing a CD	9	Recording tips	29
— Normal Play/Shuffle Play/Search Play		<hr/>	
Playing an MP3 file	10	MD – Editing	
— Normal Play/Shuffle Play/Search Play		Editing tips.....	30
Loading an MD	11	Registering tracks in groups	31
Playing an MD	12	— Group Function	
— Normal Play/Shuffle Play		Labeling an MD/group/track	32
Locating a specific track	13	— Name Function	
— AMS Function		Creating a new group.....	34
Playing repeatedly.....	14	— Create Function	
— Repeat Play		Releasing group registrations	35
Creating your own program	14	— Release Function	
— Program Play		Erasing recordings	36
Playing only the tracks in the desired group	15	— Erase Function	
Falling asleep to music.....	16	Moving recorded tracks	38
— Sleep Timer		— Move Function	
Changing the pitch of the MD	17	Combining recorded tracks.....	39
— Pitch Control Function		— Combine Function	
Using the display.....	18	Dividing recorded tracks	40
<hr/>			
MD – Recording		— Divide Function	
Before you start recording	19	Undoing the last edit.....	41
Recording a CD on an MD	20	— Undo Function	
— CD-MD Synchro Recording/High- Speed CD-MD Synchro Recording		Changing the recorded level after recording	41
Recording on an MD manually.....	21	— S.F Edit Function	
— Manual Recording		<hr/>	
Starting recording with 6 seconds of prestored audio data.....	22	Troubleshooting	
— Time Machine Recording		Problems and remedies.....	43
Marking track numbers	23	Self-diagnosis display	44
Making a space between tracks 3 seconds long automatically	24	Messages.....	45
— Smart Space		<hr/>	
Additional Information			
Precautions.....			
System limitations of MDs.....			
Specifications.....			
List of button locations and reference pages.....			



How to use this manual

- Before operating the deck, connect your deck by referring to “Getting Started.”
- This manual mainly explains operations using the remote, but the same operations can also be performed using the buttons on the deck having the same or similar names.

Playable discs

You can play back the following discs on this deck. Other discs cannot be played back.

List of playable discs

Format of discs	Disc logo	Contents
Audio CDs		Audio
MD	 MDLP	Audio
CD-R/CD-RW		Audio

You can play MP3 files on the deck. For details, see “Playing a disc with MP3 files” on page 5.

Discs that this deck cannot play

- CD-ROMs (PHOTO CDs included)
- CD-Rs/CD-RWs other than those recorded in the following formats:
 - music CD format
 - MP3 format that conforms to ISO9660*
Level 1/Level 2, Romeo or Joliet

* A logical format of files and folders on CD-ROMs, defined by ISO (International Standard Organization)

Notes on CD-R and CD-RW

- This deck can play CD-R/CD-RW discs edited by the user. However, note that playback of some discs may not be possible depending on the recording device used for recording or the disc condition.
- CD-R and CD-RW discs that have not been finalized (processing to allow play by a normal CD player) cannot be played.
- The deck may be unable to play MP3 format files that do not have the extender “.MP3” at the end of the file name.
- Attempting to play non-MP3 format files that have the extender “.MP3” may result in noise or malfunction.
- The recommended bit rate for playing MP3 files is 128kbps or more.
- Playback of dtsCDs or recording from digital dtsCDs to MDs is not supported.

Music discs encoded with copyright protection technologies

This product is designed to playback discs that conform to the Compact Disc (CD) standard. Recently, various music discs encoded with copyright protection technologies are marketed by some record companies. Please be aware that among those discs, there are some that do not conform to the CD standard and may not be playable by this product.

Playing a disc with MP3 files

About MP3 files

MP3 (MPEG 1 Audio Layer-3) is a standard technology and format for compressing a sound sequence. The file is compressed to about 1/10 of its original size. Sounds outside the range of human hearing are compressed while the sounds we can hear are not compressed.

Playback of some MP3 files may not be possible, depending on the recording.

The encoding method (i.e., the bit rate selected for encoding) will affect the sound quality of the MP3 files created. The bit rate typically used for MP3 files is 128 kbps.

About ID3 tags

An ID3 tag is song information (such as track name, album title, and artist name) that is attached to MP3 files.

Notes on discs

You can play MP3 files recorded on CD-ROMs, CD-Rs (recordable CDs), and CD-RWs (rewritable CDs). The disc must be in the ISO 9660^{*1} level 1 or level 2 format, or Joliet or Romeo in the expansion format. You can use a disc recorded in Multi Session^{*2}.

*1 ISO 9660 Format

The most common international standard for the logical format of the files and folders on a CD-ROM. There are several specification levels. In Level 1, file names must be in the 8.3 format (no more than eight characters in the name, no more than three characters in the extension “.MP3”) and in capital letters. Folder names can be no longer than eight characters. There can be no more than eight nested folder levels. Level 2 specifications allow file names up to 31 characters long.

For Joliet or Romeo in the expansion format, make sure of the contents of the writing software, etc.

*2 Multi Session

This is a recording method that enables adding of data using the Track-At-Once method.

Conventional CDs begin at a CD control area called the Lead-in and end at an area called Lead-out. A Multi Session CD has multiple sessions, with each Lead-in to Lead-out segment regarded as a single session.

CD-EXTRA: A format in which CD-DA (audio) data are recorded in the tracks of session 1 and computer data in the tracks of session 2.

Mixed CD: A format in which computer data are

recorded in the first track and CD-DA (audio) data in the following tracks within a session.

Notes

- With format other than ISO 9660 level 1, folder names or file names may not be displayed correctly.
- When naming, be sure to add the file extension “.MP3” to the file name.
- If you add the extension “.MP3” to a file other than MP3, the unit cannot recognize the file properly and will generate random noise that could damage your speakers.
- The following discs take a longer time to start playback.
 - a disc recorded with a complicated tree structure.
 - a disc recorded in Multi Session.

Cautions when playing a disc that is recorded in Multi Session

CD-DA (audio) data or MP3 files stored on a Multi Session CD may be subject to some restrictions on playback.

- If the disc begins with a CD-DA session, it is recognized as a CD-DA (audio) disc, and playback continues until an MP3 session is encountered.
- If the disc begins with an MP3 session, it is recognized as an MP3 disc, and playback continues until a CD-DA (audio) session is encountered.
- The playback range of an MP3 disc is determined by the tree structure of files produced by analyzing of the disc.
- A disc with a mixed CD format will be recognized as a CD-DA (audio) disc.

The playback order of the MP3 files

The playback order of the folders and files as follows.

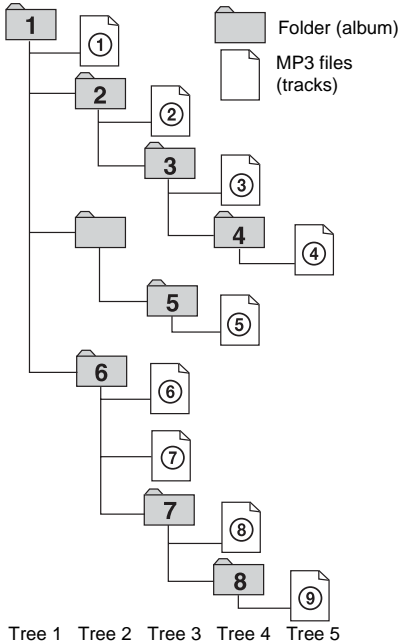

Notes

- A folder that does not include an MP3 file is skipped.
- When you insert a disc with many trees, it takes a longer time to start playback. We recommended that you make only one or two trees for each disc.
- The maximum number of MP3 files and folders is 300, and the maximum number of folders is 150 (including the root folder and empty folders).
- If the maximum number of folders or MP3 files is exceeded, the additional folder/MP3 files are not recognized. For example, if you insert the disc with 151 folders, the player reads only 150 folders.
- The CD player can play the MP3 files in a folder whose depth in the folder tree is up to 8.

Tip

To specify a desired playback order, before the folder or file name, input the order by number (e.g., "01", "02"), then record contents onto a disc. (The order differs depending on the writing software.)

Note on playback of MP3 files

Depending on the encoding/writing software, recording device, or the recording media used at the time an MP3 file is recorded, you may encounter such problems as disabled playback, sound interruptions, and noise.

About the information displayed for MP3 files

- The level meter does not function during playback.
- The following ID tags are displayed: track name/album title/artist name.
- When ID3 tags are displayed, the ID3 indicator lights up.
- When MP3 files are played, the track name is displayed as follows:
ID3v1/ID3v2/file name
- Depending on the disc, ID tags may not be displayed.
- ID tags cannot be displayed while the deck is stopped.
- The display of some characters in volume labels, album titles or track name is not supported. These characters are replaced by spaces or by characters special to the system.

Getting Started

Unpacking

Check that you received the following items:

- Audio connection cords (2)
- Remote commander (remote) (1)
- Sony R6 (size-AA) batteries (2)

Inserting two R6 (size AA) batteries into the remote

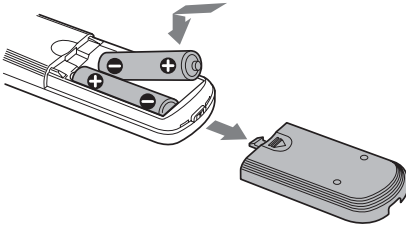

Note

If you do not use the remote for a long period of time, remove the batteries to avoid possible damage from battery leakage and corrosion.

Tip

When the remote no longer operates the deck, replace both batteries with new ones.

Hooking up

Perform the following procedures **1** to **5** to hook up your deck using the supplied cords and accessories.

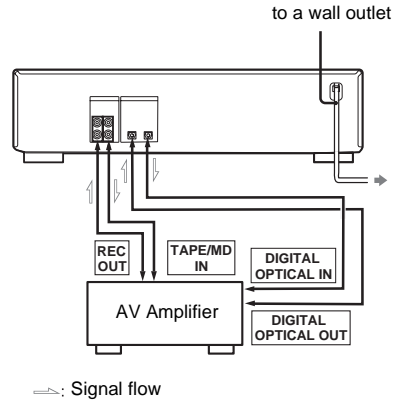

1 Prepare the cords.

- Audio connection cords (supplied) (2)



- Optical cable (not supplied) (2)



2 Connect the deck to an amplifier.

Connect the amplifier to the ANALOG IN/OUT jacks using the audio connecting cords (supplied), making sure to match the color-coded cords to the appropriate jacks on the components: red (right) to red and white (left) to white. Be sure to make connections firmly to prevent hum and noise.

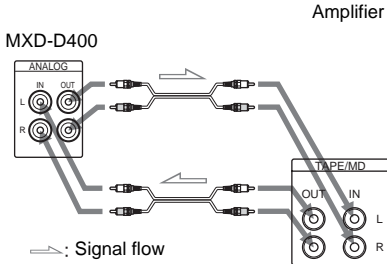

Connecting the deck to a digital component such as a digital amplifier, CD player, or an MD deck

Connect the digital component (digital amplifier, CD player, MD deck or DAT deck, etc.) to the DIGITAL OPTICAL IN/OUT connectors on the deck with an optical cable (not supplied).

Be sure to insert the plug until it clicks into place.



Tips

- If “Din Unlock” and “C71” alternate in the display, the optical cable is not connected properly. Check that the connections are secure.
- A built-in sampling rate converter automatically converts the sampling frequency of various digital sources to the 44.1 kHz sampling rate of this deck. This allows you to record source such as 32- and 48-kHz DAT or satellite broadcasts, as well as compact discs and MDs.

3 Connect the power cord to a wall outlet.

4 Turn on the amplifier and set the source selector to the position for this deck.

5 To turn on the deck, press I/⏻.
The STANDBY indicator turns off.

Loading a CD

- 1 Press OPEN/CLOSE.
- 2 Place a disc with the label side up on the disc tray.

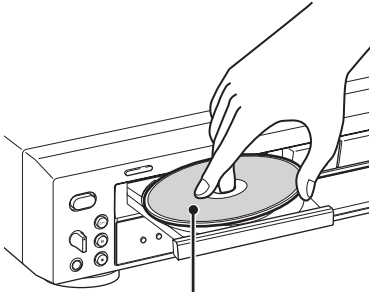

When you play a 8 cm disc, place it on the inner circle of the tray.

- 3 Press OPEN/CLOSE again to close the disc tray.

If you press \blacktriangleright instead of OPEN/CLOSE, the disc tray will close and playback will start automatically.

Notes

- Do not use a disc with tape, seals or paste on it as this may cause malfunction.
- Do not forcibly press the disc tray closed with your finger, as this may cause malfunction.

Playing a CD

— Normal Play/Shuffle Play/Search Play

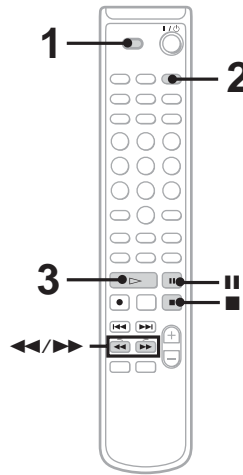

Example: When a CD is loaded

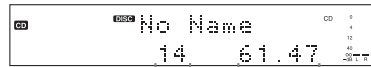

Total number of track Total playing time

- 1 Set to CD in CD MD select switch.
- 2 Press PLAY MODE in stop mode repeatedly until the mode you want appears in the display.

Select	To play
No display (Normal Play)	The tracks on the disc in original order.
SHUFFLE (Shuffle Play)	All tracks on the disc in random order.
PROGRAM (Program Play)	The tracks on the disc in the order you want them to be played (see “Creating your own program” on page 14).

- 3 Press \blacktriangleright .

Note

You cannot change the play mode during playback.

Other operations

To	Do this
Stop play	Press ■.
Pause	Press ■■. Press again to resume play.
Find a point in a track (Search)	Keep pressing ◀◀ or ▶▶ during playback and release it at the desired point.
Find a point quickly by observing the display (High-speed Search)	Keep pressing ◀◀ or ▶▶ during playback pause until you find the desired point. There is no sound output during this operation.
Remove a disc	Press OPEN/CLOSE on the deck.

Tip

If “—Over—” appears while you are pressing ▶▶, the disc has reached to its end. Press ◀◀ or ◀◀◀ (or turn AMS counter clockwise) to go back.

Note

Tracks that are only a few seconds long may be too short to scan using the search function.

Playing an MP3 file

— Normal Play/Shuffle Play/Search Play

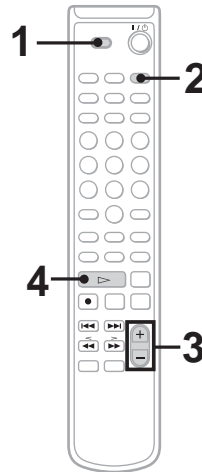

Example: When an MP3 disc is loaded

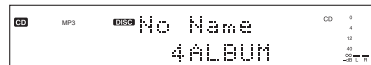

Playing the desired album

- 1 Set to CD in CD MD select switch.
- 2 Press PLAY MODE in stop mode repeatedly until the mode you want appears in the display.

Select	To play
No display (Normal Play)	The tracks on the disc in original order.
ALBUM (ALBUM Play)	All MP3 audio tracks in the album on the disc you have selected in original order.
SHUFFLE (Shuffle Play)	All tracks on the disc in random order.
ALBUM SHUFFLE (Album Shuffle Play)	The MP3 audio tracks in the album on the disc you have selected in random order.
PROGRAM (Program Play)	The tracks on the disc in the order you want them to be played (see “Creating your own program” on page 14).

- 3 Press ALBUM/GROUP – or + repeatedly until the desired album number appears.**

When using the buttons on the deck, press ALBUM (“ALBUM SELECT” appears) and turn AMS.

- 4 Press ▷.**

Playing the desired track in the album

- 1 Do step 1 to 3. (see “Playing the desired album” on page 10)**

When using the buttons on the deck, press ALBUM. “ALBUM SELECT” disappears.

- 2 Press ◀◀ or ▶▶ repeatedly (or turn AMS on the deck) until the desired title or track number appears.**

- 3 Press ▷.**

Notes

- If no album CD is played while in “ALBUM” mode, CDs are played in the same way as in “Normal Play” mode.
- If you do not select an album, playback starts from the first track of the first album.
- You cannot change the play mode during playback.
- “0.00” appears when skipping a portion of ID3 tag ver.2 (at the beginning of the track).
Skip time changes depending ID3 tag ver.2 capacity.

Other operations

See “Other operations” on page 10.

Loading an MD

Insert an MD.

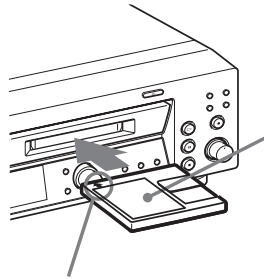

With the label side up, and the shutter on the righthand side.

With the arrow pointing toward the deck.

Tip

When you insert an MD while the deck is in standby mode, the disc tray will close and the deck will turn on automatically.

Playing an MD

— Normal Play/Shuffle Play

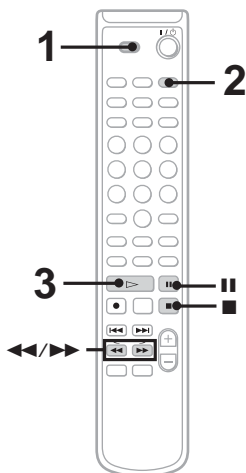

Example: When a MD is loaded

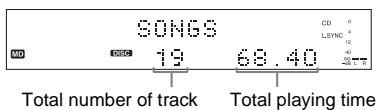

- 1 Set to MD in CD MD select switch.
- 2 Press PLAY MODE in stop mode repeatedly (or turn AMS) until the mode you want appears in the display.

Select	To play
No display (Normal Play)	The tracks on the MD in original order.
SHUFFLE (Shuffle Play)	All tracks on the MD in random order.
PROGRAM (Program Play)	The tracks on the MD in the order you want them to be played (see “Creating your own program” on page 14).

- 3 Press \triangleright .

Note

You cannot change the play mode during playback.

Other operations

To	Do this
Stop play	Press \blacksquare .
Pause	Press II . Press again to resume play.
Find a point in a track (Search)	Keep pressing \lll or \ggg during playback and release it at the desired point.
Find a point quickly by observing the display during playback pause (High-speed Search)	Keep pressing \lll or \ggg until you find the desired point. There is no sound output during this operation.
Remove a MD	Press EJECT on the deck.

Tip

If “—Over—” appears during High-speed Search, the disc has reached to its end. Press \lll or \lll (or turn AMS counter clockwise) to go back.

Notes

- If the disc reaches the end during Search, the deck stop.
- Tracks that are only a few seconds long may be too short to scan using the search function.

Locating a specific track

— AMS Function

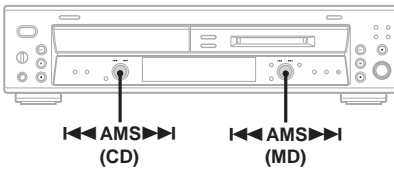
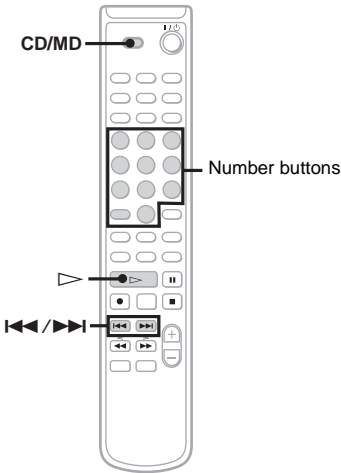

Set to CD or MD in CD MD select switch.

You can quickly locate any track by using the AMS (Automatic Music Sensor) control on the deck, **◀◀** and **▶▶** buttons on the remote, or number buttons on the remote.

To locate	Do this
The next or succeeding tracks	During playback, press ▶▶ (or turn AMS clockwise) until you find the track.
The beginning of the current or preceding tracks	During playback, press ◀◀ (or turn AMS counter clockwise) until you find the track.
A specific track by using AMS	While the deck is stopped, press ◀◀ or ▶▶ (or turn AMS), then press ▷ (or AMS).

Tips

- To go quickly to the beginning of the last track, press **◀◀** (or turn AMS counter clockwise) in stop mode.
- To pause playing at the beginning of a track, press **◀◀** or **▶▶** (or turn AMS) after pausing playback.

Playing a track by entering the track number

You can also select the desired track using the remote during Normal Play. Press the number button(s). Playback automatically starts.

To enter a track number over 10

- 1 Press **>10** once if it is a 2-digit track number, and twice if it is a 3-digit track number.
- 2 Enter the corresponding digits for the same number of “—” flashing in the display. To enter 0, press 10/0.

Examples:

- To enter 6 while “— —” flashes in the display, press 10/0, 10/0 and 6.
- To enter 100 while “— —” flashes in the display, press 1, 10/0 and 10/0.

Playing repeatedly

— Repeat Play

You can play all the tracks or a single track on a disc.

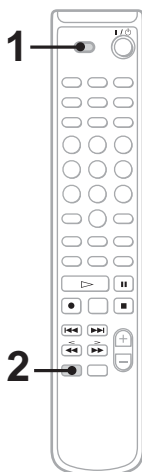

- 1** Set to CD or MD in CD MD select switch.
- 2** Press REPEAT during playback until “REPEAT” or “REPEAT 1” appears.
REPEAT: For all the tracks on the disc.
REPEAT 1: For a single track only.

To cancel Repeat Play

Press REPEAT repeatedly until both “REPEAT” and “REPEAT 1” disappear.

Tip

You can perform Repeat Play during Shuffle Play or Program Play. In Shuffle Play mode, all the tracks are shuffled and played back repeatedly. In Program Play mode, programmed tracks are played back repeatedly.

Creating your own program

— Program Play

You can make a program of up to 25 steps.

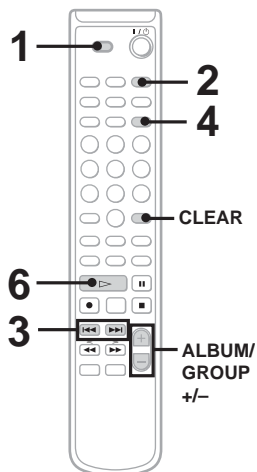

- 1** Set to CD or MD in CD MD select switch.
- 2** Press PLAY MODE in stop mode repeatedly until “PROGRAM” appears.
- 3** Press ◀ or ▶ repeatedly (or turn AMS) until the desired title or track number appears.

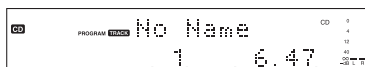

Selected track number Total playing time

AL: When you select “AL” in MP3 Play, all MP3 audio tracks in the album you have selected in original order.

- 4** Press YES (or AMS).
The track is programmed.
The step number appears, followed by the last programmed track number.
- 5** To program additional tracks, repeat steps 3 and 4.
- 6** Press ▷.
Program Play starts.

Other operations

To	Do this
Cancel Program Play	Press PLAY MODE in stop mode repeatedly until both “PROGRAM” and “SHUFFLE” disappear.
Check the program order	Press ◀◀ or ▶▶ repeatedly (or turn AMS) in pause mode.
Select the desired tracks using the number buttons	Press number buttons instead of performing steps 3 – 4.
Add a track to the end of the program	Perform steps 3 – 4 in stop mode.
Program an MP3	Press ALBUM/GROUP – or + (or press ALBUM, then turn AMS) to select album, before step 3.
Erase the program	Press CLEAR in step 4. Each time you press the button, a track is cleared from the end of the program.

Tips

- The program you made remains after Program Play finishes. To play the same program again, press ▷. However, the program is cleared when you open the disc tray, eject the MD or pull out the power cord.
- “--:--” appears when the total playing time of the CD exceeds 100 minutes or when the total playing time of the MD exceeds 1,000 minutes.
- “--:--” appears when the MP3 files are programmed. The total playing time cannot be displayed during MP3 Play.

Playing only the tracks in the desired group

This function allows you to listen only to your favorite tracks which you have registered into a group. For details of the Group Function, see “Registering tracks in groups” on page 31.

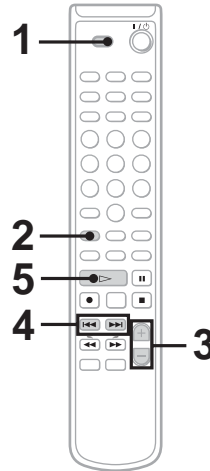

- 1** Set to MD in CD MD select switch.
- 2** Press GROUP ON/OFF in stop mode repeatedly until “GROUP ON” appears.
- 3** Press ALBUM/GROUP – or + (or GROUP SKIP) repeatedly until the desired group appears.
- 4** To start playing from a specific track in the group, press ◀◀ or ▶▶ repeatedly (or turn AMS) until the desired track appears.

Proceed to step 5 when you start playing from the first track in the group.

- 5** Press ▷.

Playback starts.

When the playing of the last track in the group finishes, the MD deck stops automatically.

Note

If you select a group that does not have any tracks registered and press \triangleright , playback starts from the first track of the first group on the MD.

Tip

You can change play mode (Normal Play/Shuffle Play/Repeat Play/Program Play) only for the tracks in the group. To select the desired play mode, select the play mode before step 3.

Falling asleep to music

— Sleep Timer

You can set the deck to turn off after a certain time, so that you can fall asleep to music. You can specify the time until the deck turns off by 30 minutes.

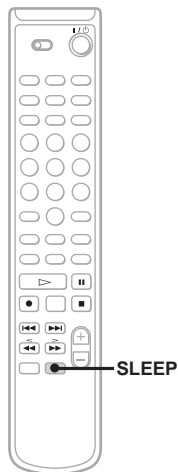

Press SLEEP.

Each time you press the button, the minute display (the turn-off time) changes cyclically as follows:

SLEEP OFF → 30min → 60min → 90min → 120min

Other operations

To	Press
Check the remaining time	SLEEP once.
Change the time to turn off	SLEEP to select the time you want.
Cancel the Sleep Timer Function	SLEEP repeatedly until "SLEEP OFF" appears.

Changing the pitch of the MD

— Pitch Control Function

You can change the pitch of the MD by lowering the playback speed. The tone falls at lower pitches.

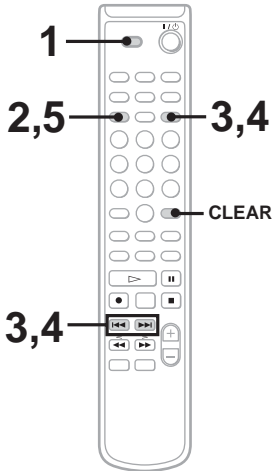

Setting the pitch automatically in steps (Auto Step Control Function)

You can lower the pitch by up to 36 steps. (One octave equals 12 steps.)

- 1 Set to MD in CD MD select switch.
- 2 Press MENU/NO repeatedly until “Setup Menu” appears.
- 3 Press ◀◀ or ▶▶ repeatedly (or turn AMS) until “Pitch” appears, then press YES (or AMS).
- 4 Press ◀◀ or ▶▶ repeatedly (or turn AMS) to select the desired step value, then press YES (or AMS).
- 5 Press MENU/NO.

Finely controlling the pitch (Fine Control Function)

You can fine control the playing speed in 0.1% increments from -87.5% to 0.0%.

- 1 Set to MD in CD MD select switch.
- 2 Press MENU/NO repeatedly until “Setup Menu” appears.
- 3 Press ◀◀ or ▶▶ repeatedly (or turn AMS) until “Pfine” appears, then press YES (or AMS).
- 4 Press ◀◀ or ▶▶ repeatedly (or turn AMS) to select the desired value, then press YES (or AMS).
- 5 Press MENU/NO.

To recall the factory setting

Press CLEAR while setting the value.

Notes

- The playing sound drops out momentarily when you change the fine control value.
- The fine control value reverts to “0.0%” (factory setting) and the step value returns to “0” (factory setting) when you turn off the deck or eject the MD.
- When a dot (.) appears to the right of the step value in the pitch display, this indicates that you have performed fine adjustment (see this page) and the pitch value is between steps. The step and fine control values are linked; changing one value also changes the other.

Using the display

You can use the display to check disc and track information such as total track number, total playing time of the tracks, track number and remaining time of the current track, remaining recordable time of the MD, and disc name.

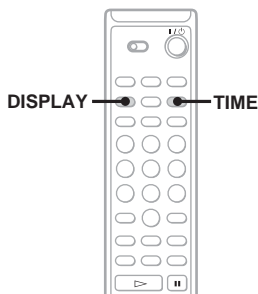

Changing the display

Each time you press DISPLAY while the deck is stopped or playing, you can change the display as follows:

CD/MD divided display → Detailed display for CD player section → Detailed display for MD player section

CD/MD divided display

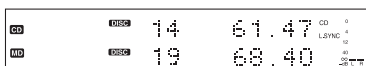

Detailed display for CD player section

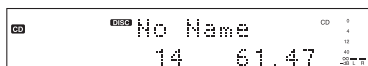

Detailed display for MD deck section

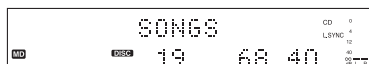

Tips

- Whenever you change the operation status of the deck, the display automatically changes to reflect that status.

- When either of the detailed display is selected, the disc name appears whenever the deck is stopped. The name of the current track appears when a track is playing. If the CD has no text information or no title is recorded on the MD, "No Name" appears instead.
- If you insert a CD containing CD TEXT data, "CD TEXT" light up in the display.
- To scroll a long name, press SCROLL. Press SCROLL again to pause scrolling, and again to continue scroll.
- When you load a disc with MP3 files, the total playing time is not displayed.

Checking the remaining time and titles

Press TIME during Normal Play.

Each time you press the button, the display changes cyclically as follows:

■ When playing a CD

Current track number and elapsed playing time
→ Current track number and remaining time
→ Remaining time of the current disc^{*1}

■ When playing an MD

Current track number and elapsed playing time
→ Current track number and remaining time
→ Remaining time of the MD^{*2}

^{*1} These are not displayed during MP3 Play.

^{*2} When the Group Function is on, the remaining time of all tracks in the group is displayed.

Checking the remaining recordable time of the MD

- 1 Set to MD in CD MD select switch.
- 2 Press TIME in stop mode.

Each time you press the button, the display changes cyclically as follows:

Total number of tracks and the total playing time^{*3} → Remaining recordable time (recordable MD only)

^{*3} When the Group Function is on, the total number of groups (when no group is selected) or the total number of tracks and the total playing time within the group (when a group is selected) are displayed.

Before you start recording

MDs (MiniDisc) let you digitally record and play music with high quality sound. Another feature of MDs is track marking. The track marking feature lets you quickly locate a specific point or easily edit the recorded tracks. However, depending on the source you record, the recording method and the way the track numbers are recorded differ.

When the source you record from is:

- CDs loaded in this deck's CD player
 - The MD deck performs digital recording.*
 - Track numbers are automatically marked as on the original CD. However, track numbers are not marked depending on the track (page 5).
- Other digital components connected to the DIGITAL OPTICAL IN jack
 - The MD deck performs digital recording.*
 - Track numbers are marked differently depending on the source you record.
- Other analog components connected to the ANALOG IN jacks
 - The MD deck performs analog recording.
 - A track number is marked at the beginning of a recording only, but when you turn on the Level Synchro Recording Function (page 23), track numbers are automatically marked in sync with the level of the input signal.

Note on MD track numbers

On an MD, the track numbers (track sequence), track start and end point information, etc., are recorded in the TOC** area independent of the sound information. You can edit recorded tracks quickly by modifying the TOC information.

When recording MP-3 format files on a CD-R or CD-RW

Only normal-speed CD synchro recording is supported. This is because the digital signal of the MP3 file is first converted to an analog signal before it is recorded.

About recording errors

- With the following kinds of discs, you may experience a reading failure or noise when recorded on an MD:
 - Discs with adhesive labels attached to them
 - Irregularly shaped discs (for example, heart- or star- shaped)
 - Discs with printed text concentrated on one side only
 - Scratched discs
 - Dirty discs
 - Warped discs
- If the following occurs during CD playback or recording, a reading error may occur or noise may be produced in the recorded results:
 - The disc tray or other part of the deck is bumped.
 - The deck is placed on an uneven or soft surface.
 - The deck is located near a speaker, door, or other source of vibration.
- If the above reading errors occur, an extra soundless track may be created. You can erase these extra tracks using Erase Function (page 36).

* For details on the limitations of digital recording, see “System limitations of MDs” on page 47.

** TOC: Table Of Contents

After recording

Press **EJECT** to remove the MD or press **I/⏻** (power) to turn off the deck.

“TOC” starts flashing. The TOC is updated and recording is completed.

Before pulling out the power cord MD recording is completed when the MD Table of Contents (TOC) is updated. The TOC is updated when you eject the MD or press **I/⏻** to turn off the deck. Do not pull out the mains lead before updating the TOC or while updating the TOC (while “TOC” lights up or flashes) to ensure a complete recording.

Protecting a recorded MD

- To protect a recorded MD, slide the tab on the side of the MD to open the slot. In this position, the MD cannot be recorded. To record on the MD, slide the tab to close the slot.

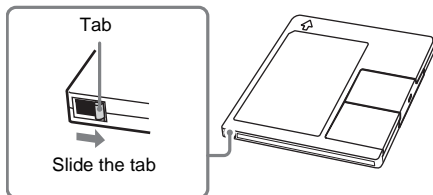

- If the MD is record protected, “C11” and “Protected” appear alternately and the MD cannot be recorded. Remove the MD, then slide the record protection tab to the closed position.

Recording a CD on an MD

— CD-MD Synchro Recording/High-Speed CD-MD Synchro Recording

You can record a whole CD on an MD. You can select the recording time by switching the recording mode.

In addition to recording at normal speed, you can also record at high speed (approximately 4× normal speed).

When using the remote, switch the function to MD.

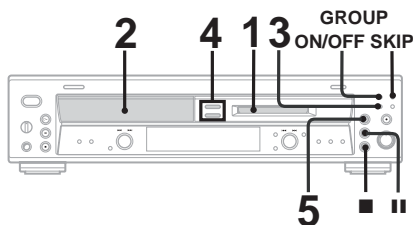

- 1 Load a recordable MD.
- 2 Load a CD you want to record.
- 3 Press **REC MODE** repeatedly to select the recording mode.

Select the desired recording time.

To record in	Select	Recording time*
Stereo	Blank (No indicator)	60 minutes
LP2 Stereo	LP2	120 minutes
LP4 Stereo	LP4	240 minutes
Monaural	MONO	120 minutes

*Maximum recording time using a 60-minute MD.

- 4 Press **CD SYNCHRO NORMAL** or **HIGH**.

To record using High-Speed CD-MD Synchro Recording, press **HIGH**.

The MD deck stands by for recording and the CD player pauses for play.

- 5 After “New Track” is displayed, press **▷** or **||** on the MD deck.

Recording starts.

When the recording is completed, the CD player and the MD deck stop automatically.

To stop recording

Press ■.

To record using the Group Function

Press GROUP ON/OFF repeatedly until “GROUP ON” appears after step 2. Press ALBUM/GROUP – or + (or GROUP SKIP) repeatedly until “New Group” or the desired group appears after step 4.

To record only your favorite CD tracks

You can record only your favorite CD tracks using the Program Play. Between steps 2 and 3, perform steps 1 to 5 of “Creating your own program” (page 14).

About recording MP3 files

- When recording MP3 files, the files are converted to audio CD format. This may cause the data volume to increase beyond the capacity of the disc.
- To protect copyrighted music contents, the following restrictions are applied when recording MP3 files on the deck:
 - 1) Only normal-speed CD synchro recording is supported.
 - 2) The digital signal of the MP3 files is converted to an analog signal before it is recorded.
 - 3) The recording level cannot be adjusted.
- During recording, the elapsed time for the CD and MD on the display may differ slightly. This does not constitute a problem.

Notes

- You cannot pause the recording.
- If the MD play mode is set to the Shuffle Play or Program Play, the play mode switches to Normal Play in step 5.

Tips

- For details about LP2/LP4 recording, see “Recording for long times” on page 29.
- For details about High-Speed CD-MD Synchro Recording, see page 29.

Recording on an MD manually

— Manual Recording

You can record just the portions you like from a CD, or other connected component.

When using the remote, switch the function to MD.

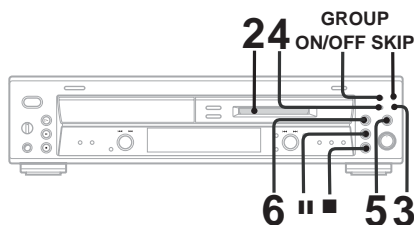

- 1 Load a recordable MD.**
- 2 Press INPUT repeatedly to select the desired source to record.**
 - CD: To record from this deck’s CD player.
 - OPT: To record from the digital component connected to the DIGITAL OPTICAL IN jack.
 - ANALOG: To record from the analog component connected to the ANALOG IN jacks.
- 3 Press REC MODE repeatedly to select the recording mode.**

Select the desired recording time.

To record in	Select	Recording time*
Stereo	Blank (No indicator)	60 minutes
LP2 Stereo	LP2	120 minutes
LP4 Stereo	LP4	240 minutes
Monaural	MONO	120 minutes

*Maximum recording time using a 60-minute MD.

- 4 Press REC ●.**
The MD deck stands by for recording.
- 5 Press ▷, then start playing the desired source to record.**

continued

To stop recording

Press ■.

To record using the Group Function

Press GROUP ON/OFF repeatedly until “GROUP ON” appears after step 2. Press ALBUM/GROUP – or + (or GROUP SKIP) repeatedly until “New Group” or the desired group appears after step 3.

Notes

You cannot record over existing tracks. The new tracks are recorded after the existing tracks.

Tips

- You can check the remaining recordable time on the MD during recording by pressing TIME.
- For details about LP2/LP4 recording, see “Recording for long times” on page 29.
- You can adjust the recording level (page 25).

Starting recording with 6 seconds of prestored audio data

— Time Machine Recording

When recording from an FM or satellite broadcast, the first few seconds of material are often lost due to the time it takes you to ascertain the contents and press the record button. To prevent the loss of this material, the Time Machine Recording feature constantly stores the most recent audio data in a buffer memory. This lets you record the sound from 6 seconds before starting recording, as shown in the illustration below:

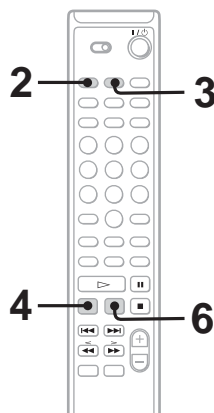
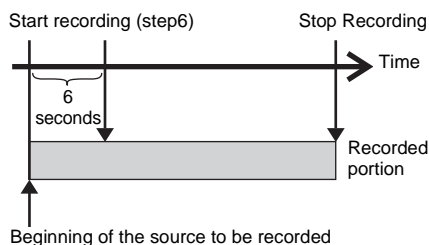

- 1 Load a recordable MD.
- 2 Press INPUT repeatedly to select the desired source to record.

3 Press REC MODE repeatedly to select the recording mode.

Select the desired recording time.

To record in	Select	Recording time*
Stereo	Blank (No indicator)	60 minutes
LP2 Stereo	LP2	120 minutes
LP4 Stereo	LP4	240 minutes
Monaural	MONO	120 minutes

*Maximum recording time using a 60-minute MD.

4 Press ●.

The MD deck stands by for recording.

5 Start playing the desired source to record.

6 Press T.REC at the desired point to start recording.

To stop Time Machine Recording

Press ■.

Note

The MD deck starts storing audio data when the deck stands by for recording in step 4 and you start playing the source. If less than 6 seconds have passed when you press T.REC (or AMS), Time Machine Recording starts with less than 6 seconds of audio data.

Tip

For details about LP2/LP4 recording, see “Recording for long times” on page 29.

Marking track numbers

After recording

Use the Divide Function (page 40).

At any point during recording

— **Track Mark**

You can mark track numbers during manual recording of any source.

Press ● during manual recording at the point you want to add a track mark.

Presetting to automatically mark track numbers before recording

— **Level-Synchro Recording**

The Level Synchro Recording Function is factory set to on, so the track numbers are automatically marked. Track numbers are automatically marked when the input signal is continuously below a certain level for more than two seconds and then exceeds that level. If “L.SYNC” does not appear during recording, turn on the Level Synchro Recording as follows.

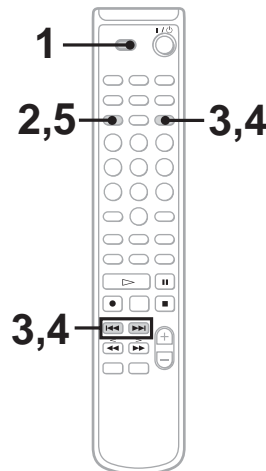

- 1 Set to MD in CD MD select switch.
- 2 Press MENU/NO repeatedly until "Setup Menu" appears.
- 3 Press ◀◀ or ▶▶ repeatedly (or turn AMS) until "T.Mark" appears, then press YES (or AMS).
- 4 Press ◀◀ or ▶▶ repeatedly (or turn AMS) until "T.Mark LSync" appears, then press YES (or AMS). "L.SYNC" lights up.
- 5 Press MENU/NO.

To continue recording, follow the procedures described for each type of recording.

Other operations

To	Do this
Turn off the Level Synchro Recording Function	In step 4, press ◀◀ or ▶▶ repeatedly (or turn AMS) until "T.Mark Off" appears, then press YES (or AMS).
Change the trigger lever for Level Synchro Recording*	After step 2, press ◀◀ or ▶▶ repeatedly (or turn AMS) until "LS(T)" appears, then press YES (or AMS). Press ◀◀ or ▶▶ repeatedly (or turn AMS) to select the level between -72 dB and 0 dB (in 2 dB steps), press YES (or AMS), then press MENU/NO.

* When the recording source is tape or radio program and the track numbers are not marked properly because of noise, set this level higher so that track numbers are marked easily. The factory setting is "-50 dB".

Notes

- Track numbers are not marked depending on the track.
- When recording a CD, track numbers are marked where you paused recording. In addition, the tracks might be recorded as the same single track with a single track number when the same single track of the same CD is recorded repeatedly.

Making a space between tracks 3 seconds long automatically

— Smart Space

Smart Space: Lets you make the blank spaces between tracks 3 seconds long automatically while making a digital recording from a CD. For other types of recording, if the Smart Space Function is on and there is no sound input for about 3 seconds or more (but less than 30 seconds) while recording, the MD deck replaces this silence with a blank of about 3 seconds and continues recording. The Smart Space Function is factory set to on.

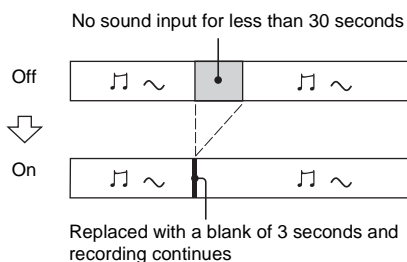

Auto Cut: When the Smart Space Function is on, if there is no sound input for 30 seconds or more, the MD deck replaces this silence with a blank of about 3 seconds and enters recording pause.

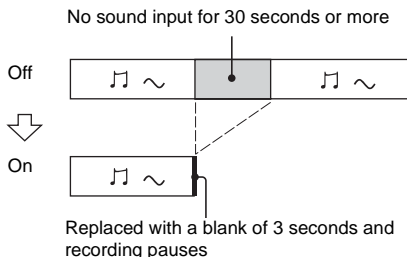

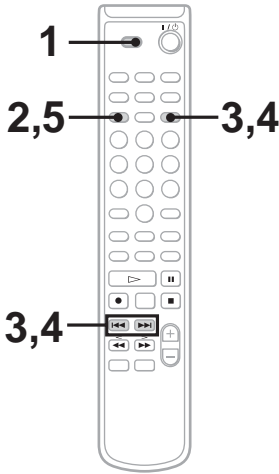

- 1** Set to MD in CD MD select switch.
- 2** Press MENU/NO repeatedly until “Setup Menu” appears.
- 3** Press ◀◀ or ▶▶ repeatedly (or turn AMS) until “S.Space Off” appears, then press YES (or AMS).
- 4** Press ◀◀ or ▶▶ repeatedly (or turn AMS) until “S.Space On” appears, then press YES (or AMS).
- 5** Press MENU/NO.

To continue recording, follow the procedures described for each type of recording.

To turn off the Smart Space Function

In step 3, press ◀◀ or ▶▶ repeatedly (or turn AMS) until “S.Space On” appears, then press YES (or AMS).

In step 4, press ◀◀ or ▶▶ repeatedly (or turn AMS) until “S.Space Off” appears, then press YES (or AMS).

Adjusting the recording level

When recording on an MD, you can adjust the recording level to the desired volume. You can adjust the recording level not only when making an analog recording, but also when making a digital recording from a CD, etc. Adjusting the analog recording level can be performed using the buttons on the deck only.

Adjusting the recording level when making an analog recording

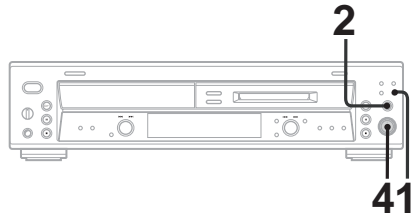

- 1** Press INPUT repeatedly until “ANALOG” appears.
- 2** Press REC ●.
- The MD deck stands by for recording.
- 3** Start playing the desired source to record.
- 4** Turn REC LEVEL on the deck to adjust the recording level.

Adjust to the optimum level while making sure that “OVER” does not appear in the display at the loudest portion.

Adjust the level so as not to light up “OVER”.



5 Stop playing the sound source.

To continue recording, follow the procedures described for each type of recording.

Adjusting the recording level when making a digital recording

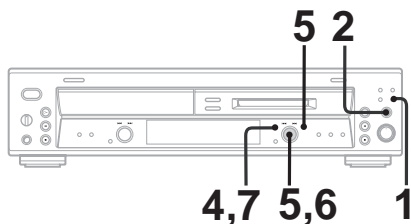
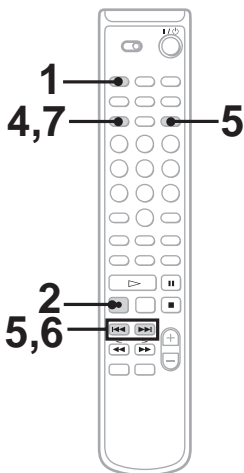

1 Press **INPUT** repeatedly until “CD” or “OPT” appears.

2 Press **REC** ●.

The MD deck stands by for recording.

3 Start playing the desired source to record.

4 Press **MENU/NO** repeatedly until “Setup Menu” appears.

5 Press **◀▶** or **▶▶** repeatedly (or turn **AMS**) until “CD” or “OPT” appears, then press **YES** (or **AMS**).

6 Press **◀▶** or **▶▶** repeatedly (or turn **AMS**) to adjust the recording level.

Adjust to the optimum level while making sure that “OVER” does not appear in the display at the loudest portion.

7 Press **MENU/NO**.

8 Stop playing the sound source.

Tips

- You can also adjust the recording level during recording.
- Once adjusted, the recording level is maintained until you adjust it again.
- You cannot adjust the recording level during CD-MD Synchro Recording.
- You cannot adjust the recording level during MD playback.

Recording the current CD track

— REC-IT Function

You can record specific tracks on a CD while listening to them. This function allows you to put only the tracks you like onto the MD.

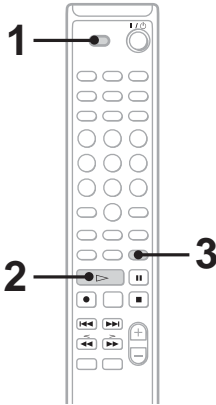

1 Set to CD in CD MD select switch.

2 Press \blacktriangleright to start playback.

Make sure that the MD deck section is stopped.

3 Press REC-IT when you hear a track you want to record.

Play returns to the start of the track and recording starts. The recording stops at the end of the track, but CD playback continues from the next track.

To stop Recording

Press \blacksquare .

Note

- Make sure that the remaining recordable time on the MD is longer than the playing time of the CD track.
- The recording level specified in the Setup Menu is not applied during REC-IT Recording. The initial reference level (0.0 dB) is used instead.
- During MP3 playback, REC-IT Recording cannot be made. For details about the MP3 recording, See “When recording MP-3 format files on a CD-R or CD-RW” on page 19

Synchro-Recording with an external audio equipment

— Music Synchro-Recording

By using the MUSIC SYNC button on the remote, you can automatically start recording in sync with a CD in the deck or the signal input from the program source connected to the deck.

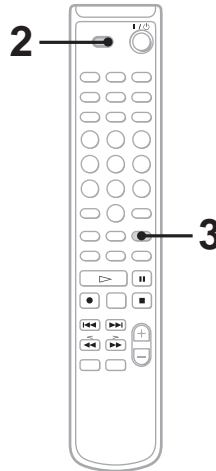

1 Do steps 1 to 4. (see “Recording on an MD manually” on page 21).

2 Switch the function to MD.

3 Press MUSIC SYNC.

“REC” and “SYNC” flash and the deck changes to recording pause.

4 Start playing the program source you want to record.

The deck starts recording automatically.

To stop Music Synchro-Recording

Press \blacksquare .

Note

When Music Synchro-Recording, the Smart Space Function and the Auto Cut Function turn on automatically regardless of their setting (“On” or “Off”).

Fading in and out

— *Fader*

You can gradually increase the recording level at the beginning of a recording (fade-in recording) or gradually decrease the recording level at the end of a recording (fade-out recording).

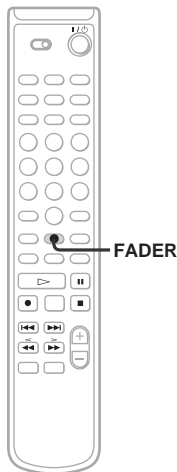

Fade-out recording

During recording pause, press FADER at the position where you want to start fade-out recording.

▶ flashes and the deck performs the fade-out recording until the counter reaches “0.0s.”

Tip

You can set the duration of fade-in and fade-out recording independently (page 42).

Fade-in recording

During recording pause, press FADER at the position where you want to start fade-in recording.

◀ flashes and the deck performs the fade-in recording until the counter reaches “0.0s.”

Recording tips

Recording for long times

This deck has two long time recording modes: LP2 and LP4 (MDLP recording).

Press REC MODE to select the recording mode. Refer to each pages about recording (pages 20 and 21).

MDs recorded in MDLP Stereo mode are played back only on the deck with the following marks.

MDLP MDLP

MDs recorded in MDLP Stereo mode cannot be played back on the deck that does not support MDLP mode.

Notes

- Even if the recording mode is set to “MONO”, the sound from the speakers are output as recorded in the source (in stereo when recording the stereo source).
- Some MDs recorded in MDLP Stereo mode are edited so that “LP:” is displayed to indicate that playback is not possible when an attempt is made to play back these MDs on a deck that does not support MDLP mode. However, this deck supports MDLP mode, so “LP:” is not displayed when these MDs are played back.

Tips

- LP4 stereo mode (4× long time recording mode) achieves a long stereo recording time by use of a special compression deck. When placing emphasis on sound quality, Stereo recording or LP2 stereo recording (2× long time recording mode) is recommended.
- You can mix the recording mode in an MD.
- The selected recording mode is kept even after recording has finished. To change the recording mode, press REC MODE repeatedly.

High-Speed CD-MD Synchro Recording

When recording an entire CD as is or in the programmed track order, you can record at higher speed than normal (approximately 4× normal speed).

If you cannot use High-Speed CD-MD Synchro Recording

A reading failure has occurred, and the deck is trying to read the data again.

- If the retry was successful, the deck continues with High-Speed CD-MD Synchro Recording.
- If the condition of the inserted CD or the deck is poor, and retry fails, High-Speed CD-MD Synchro Recording is disabled. In this case, “Retry” and “NORMAL” flash in the display and the MD deck automatically starts recording in normal CD-MD Synchro Recording. Note the monitoring of the recorded signal is not possible when this occurs.

Notes

- You cannot record over existing tracks. The new tracks are recorded after the existing tracks.
- When recording all the tracks on a CD, be sure to use a recording MD with a longer remaining time than the CD play time.
- You cannot pause recording during CD-MD Synchro Recording and High-Speed CD-MD Synchro Recording.
- If the CD play mode is set to Repeat Play or Shuffle Play, it automatically switches to Normal Play.
- The following items are either inoperative or cannot be used during High-Speed CD-MD Synchro Recording:
 - The Auto Cut Function
 - The recording level specified in the Setup menu
- There is no sound output during High-Speed CD-MD Synchro Recording.

MD – Editing

Editing tips

Before you start editing

You can edit an MD only when:

- The MD is recordable.
- The MD play mode is Normal Play.

Check the following, before editing.

1 Check the tab of the MD to be edited.

Slide the tab to close the slot.

If the MD is protected, you cannot edit the MD.

2 Press **PLAY MODE** repeatedly until both “**SHUFFLE**” and “**PROGRAM**” disappear.

You can edit the MD only in Normal Play mode. You cannot edit the MD in Shuffle or Program Play mode.

To quit while editing

Press MENU/NO.

Operation buttons for Editing

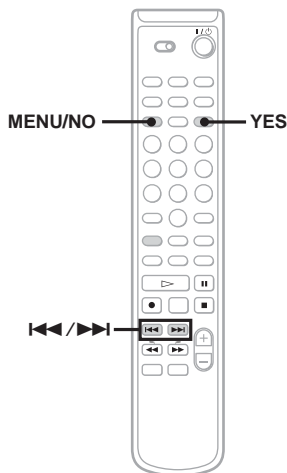

After editing

Press EJECT to remove the MD or press I/⏻ (power) to turn off the deck.

“TOC” starts flashing. The TOC is updated and editing is completed.

Before pulling out the mains lead

MD editing is completed when the MD Table of Contents (TOC) is updated. The TOC is updated when you eject the MD or press I/⏻ to turn off the deck. Do not pull out the mains lead before updating the TOC or while updating the TOC (while “TOC” lights up or flashes) to ensure a complete editing.

Registering tracks in groups

— Group Function

What is the Group Function?

The Group Function allows you to play, record and edit the tracks on an MD in groups. For example, you can register tracks 1 to 5 on an MD to the “Rock” group, and tracks 6 to 9 to the “Pops” group. Then you can listen to the tracks in only the desired group, add new tracks to a group, and perform other operations. In addition, the Group Function can be easily turned on and off simply by pressing GROUP ON/OFF.

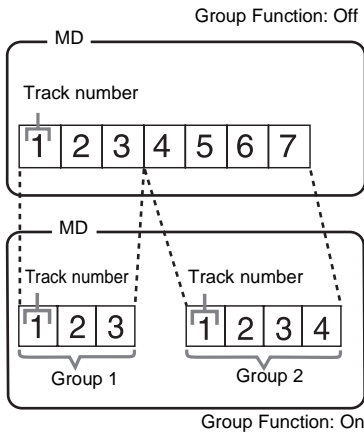

When the group function is turned on, track numbers within groups are renumbered, starting from track 1. In the above figure, for example, tracks 4 to 7 are renumbered to 1 to 4 when the group function is turned on.

Operations using the Group Function

- Playing only the tracks in the desired group (page 15)
- Recording a CD (page 20)
- Recording on an MD manually (page 21)
- Starting recording with 6 seconds of prestored audio data (page 22)
- Labeling a group (page 32)
- Registering recorded tracks into a new group (page 35)
- Releasing group registrations (page 35)

Note

MDs recorded using the Group Function of this deck can be used with other deck that supports the Group Function. However, note that the Group Function operations of other deck may differ from the operations for this deck.

How is group information recorded?

When recording using the Group Function, the group management information is automatically recorded on the MD as the disc title. Specifically, a character string such as the following is written in the disc title recording area.

Disc title recording area

0 ; Favourites // 1 - 5 ; Rock // 6 - 9 ; Pops // ...

① ② ③

- ① The disc title is “Favorites”.
- ② Tracks 1 to 5 are registered in the “Rock” group.
- ③ Tracks 6 to 9 are registered in the “Pops” group.

Therefore, when an MD recorded using the Group Function is loaded on a deck that does not support the Group Function or on this deck with the Group Function turned off, the above character string is displayed in its entirety as the disc title.

Note that if you rewrite this character string by mistake using the Name Function, you may be unable to use the Group Function of that MD.*

* "GROUP ON" flashes. To use the Group Function again, first perform the procedure for "Releasing all groups on an MD" (page 36) and release the registrations of all tracks on the MD.

If "Group Full!" appears during operation

You cannot start recording because there is insufficient character space for group management. Delete unnecessary characters (disc title or track titles) until group recording is possible (page 34).

Notes

- The Group Function setting is stored even if you eject the MD or turn off the deck.
- When the Group Function is on, tracks which are not registered to a group are not displayed and cannot be played.
- You cannot change the group order.
- The new group is added after any existing groups with tracks registered.
- When you newly record a track into an existing group, the new track is added after any existing tracks in the group.
- Up to 99 groups can be registered on a single MD.
- When you newly record a track into an existing group, the track numbers following the newly recorded track may change when the Group Function is turned off.
- If you load a disc with group management information written in other than the proper format, "GROUP ON" flashes. In this case you cannot use the Group Function.

Labeling an MD/group/track

— Name Function

You can create titles for your recorded MDs, tracks, and groups as follows.

After recording

Use Name Function. You can input a total of approximately 1,700 characters for the disc title, track titles and group titles on a single MD.

When labeling an MD recorded using the Group Function, be sure to label the disc with the Group Function on so as not to rewrite the group management information by mistake.

For details on the group management information, see "How is group information recorded?" on page 31.

Labeling using the buttons on the remote

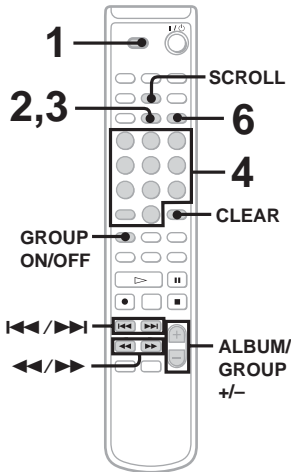

1 Set to MD in CD MD select switch.

2 Perform the following procedure depending on what you want to label:

To label a track

Press **◀◀** or **▶▶** repeatedly until the desired track number appears, then press **NAME EDIT/SELECT**.

To label an MD

Press **NAME EDIT/SELECT** while the total number of tracks (or groups when the Group Function is on) is displayed.

To label a group

Press **GROUP ON/OFF** repeatedly until “GROUP ON” appears, then press **ALBUM/GROUP –** or **+** repeatedly until the desired group appears. Press **NAME EDIT/SELECT** while the total number of tracks within the desired group is displayed.

The cursor starts flashing.

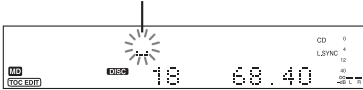

3 Press NAME EDIT/SELECT to select the desired type of character.

Character type	Select
Alphabet (upper cases)/ blank space/symbols	Selected AB
Alphabet (lower cases)/ blank space/symbols	Selected ab
Numbers	Selected 12

4 Enter a character.

Character type	Do this
Alphabet	Press the corresponding letter button (or ◀◀ or ▶▶) repeatedly until the character to be entered flashes, then press ▶▶ .
Numbers	Press the corresponding number buttons.
Blank space	Press 10/0 .
^ - / , . () : ! ?	Press 1 repeatedly.
& + < > _ = " ; # \$ % @ * `	Press 1 , then press ◀◀ or ▶▶ repeatedly.

5 Repeat steps 3 and 4 to enter the rest of the name.

6 Press YES.

To change the character

In step 3 or 4, press **◀◀** or **▶▶** repeatedly until the character to be changed flashes, press **CLEAR** to erase the character, then repeat steps 3 and 4.

To add a character

After steps 1 and 2, press **◀◀** or **▶▶** until the cursor comes to the point you want to add a character, then proceed to step 3.

Labeling using the buttons on the deck

- 1 Press **MENU/NO** repeatedly until “Edit Menu” appears.
- 2 Turn **AMS** until “Nm In?” appears in the display and press **AMS**.
- 3 Turn **AMS** to select “Disc” to label an MD, or to specify the track or group to label. While recording, go to step 5.
- 4 Press **AMS** or **YES**.
A flashing cursor appears in the display. The deck starts playing and you can name a track while monitoring the sound.
- 5 Press **TIME** to change the type.

Character type	Select
Alphabet (upper cases)	“A”
Alphabet (lower cases)	“a”
Numbers	“0”
Symbols	“ / ”

- 6 Turn **AMS** to select the character. The selected character flashes. Letters, numbers, symbols, and a space appear in sequential order as you turn **AMS**. To enter a space, press **AMS** while the cursor is flashing. (You cannot select a space for the first character to the title.)
- 7 Press **AMS** to enter the select character. The selected character stops flashing and the cursor flashes waiting for the input of the next character.
- 8 Repeat steps 6 and 7 until you have entered the entire title.
- 9 Press **YES**.

continued

Note

If you enter the symbol “//” between the characters in disc titles such as “abc//def”, you may be unable to use the Group Function.

Tips

- You can label a track title during playback. The playback repeats until you finish labeling.
- During the CD-MD Synchro Recording (page 20), CD-TEXT information is recorded automatically.

Checking the titles

To check the disc titles, press **SCROLL** in stop mode. To check the track title, press **SCROLL** during playback. The title appears scrolling in the display.

To check the group titles, press **GROUP ON/OFF** repeatedly in stop mode until “**GROUP ON**” appears, press **ALBUM/GROUP –** or **+** (or **GROUP SKIP**) repeatedly until the desired group appears, then press **SCROLL**.

To stop scrolling, press **SCROLL**. Press the button again to resume scrolling.

Erasing the titles

- 1 To erase group titles, press **GROUP ON/OFF** repeatedly in stop mode until “**GROUP ON**” appears.**
- 2 Press **MENU/NO** in stop mode.**
- 3 Press **◀◀** or **▶▶** repeatedly (or turn **AMS**) until “**Nm Erase?**” appears, then press **YES** (or **AMS**).**
- 4 Press **◀◀** or **▶▶** repeatedly until “**Disc**” (to erase the disc title), the track title or the group title appears**
- 5 Press **YES** (or **AMS**).**
“Complete!” appears.

Note

You cannot erase the title of a group that does not have any tracks registered.

Creating a new group

— Create Function

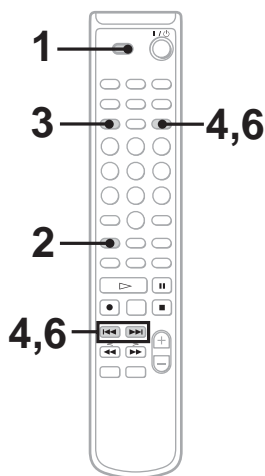

The Create Function allows you to create a new group without registering any tracks, or to create a new group and register one or more consecutive tracks into that group. Only tracks that have not yet been registered into any group can be registered.

For details on the Group Function, see “Registering tracks in groups” on page 31.

- 1 Set to MD in CD MD select switch.**
- 2 Press **GROUP ON/OFF** repeatedly until “**GROUP ON**” appears.**
- 3 Press **MENU/NO**.**
- 4 Press **◀◀** or **▶▶** repeatedly (or turn **AMS**) until “**Gp Create?**” appears, then press **YES** (or **AMS**).**
- 5 Perform steps 3 to 6 of “Labeling an MD/group/track” (page 32).**
- 6 Press **◀◀** or **▶▶** repeatedly (or turn **AMS**) until “**Assign None**” appears, then press **YES** (or **AMS**).**

Note

When creating a group without registering any tracks, you must enter the group title.

To register tracks into a group

In step 6, press **◀◀** or **▶▶** repeatedly (or turn AMS) to select the number of the first track you want to register, then press **YES** (or AMS).

When registering only one track, press **YES** again. When registering two or more tracks, press **◀◀** or **▶▶** (or turn AMS) repeatedly to select the number of the last track you want to register, then press **YES** (or AMS).

Notes

- You cannot register the same track to more than one group.
- If you do not enter a group title in step 5, “Group ** (group number)” appears as the group title.

Tip

You can also register tracks that were recorded on a deck that does not support the Group Function.

Releasing group registrations

— Release Function

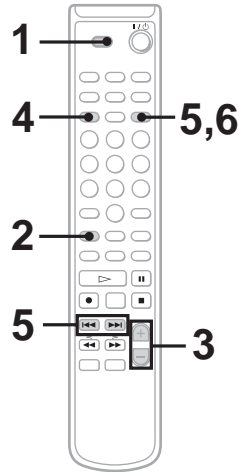

These functions allow you to release group registrations simply by specifying the group for which you want to release the registrations. In addition, you can also release the registrations of all groups on an MD at once.

For details on the group management information, see “Registering tracks in groups” on page 31.

Releasing a single group

— Group Release Function

You can release a specified group and erase that group. (However, note that the tracks are not erased.)

- 1** Set to MD in CD MD select switch.
- 2** Press **GROUP ON/OFF** repeatedly until “**GROUP ON**” appears.
- 3** Press **ALBUM/GROUP - or + (or GROUP SKIP)** repeatedly until the desired group appears.
- 4** Press **MENU/NO**.

continued

- 5 Press **◀◀** or **▶▶** repeatedly (or turn AMS) until “Gp Release?” appears, then press YES (or AMS).

“REL Gp** (selected group number)?” appears.

- 6 Press YES (or AMS).

Releasing all groups on an MD

— All Release Function

- 1 In step 5 above, press **◀◀** or **▶▶** repeatedly (or turn AMS) repeatedly until “Gp All REL?” appears, then press YES (or AMS).

“All REL??” appears.

- 2 Press YES (or AMS).

Erasing recordings

— Erase Function

The MD deck lets you erase unwanted tracks quickly and easily.

You can restore the erased contents using the Undo function immediately after the erasing (page 41). However, you cannot restore the erased contents after performing other editing. Before erasing, make sure if it is all right to erase the content.

The three options for erasing recordings are:

- Erasing a single track (Track Erase Function)
- Erasing all tracks (All Erase Function)
- Erasing a portion of a track (A-B Erase Function)

Erasing a single track

— Track Erase Function

When you erase a track, the total number of tracks on the MD decreases by one and all the tracks following the erased one are renumbered.

Example: Erasing track 2

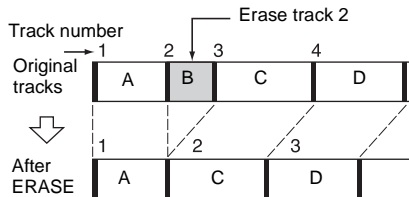

As the track numbers are renumbered as above, it is recommended to erase from the latter tracks when erasing several tracks, so as not to change the track numbering of unerased tracks.

- 1 Set to MD in CD MD select switch.
- 2 Press MENU/NO.
- 3 Press **◀◀** or **▶▶** repeatedly (or turn AMS) until “Tr Erase?” appears, then press YES (or AMS).

Playback of the selected track starts.

4 Press **◀◀** or **▶▶** repeatedly (or turn **AMS**) until the desired track number appears.

5 Press **YES** (or **AMS**).

“Complete!” appears. The track selected in step 4 is erased and playback of the following track starts. When you erase the last track, the playback of the previous track starts.

Note

If you erase all the tracks within a group, the group itself is also erased.

Erasing all tracks

— All Erase Function

You can erase all the contents recorded on an MD (the disc title, group titles, all recorded tracks and their titles) at once.

- 1** Set to MD in CD MD select switch.
- 2** Press **MENU/NO**.
- 3** Press **◀◀** or **▶▶** repeatedly (or turn **AMS**) until “All Erase?” appears, then press **YES** (or **AMS**).
“All Erase?” appears.
- 4** Press **YES** (or **AMS**) again.

Note

If you perform the above operation when the Group Function is on, not only the tracks within the group, but all the tracks on the MD are erased.

Erasing a portion of a track

— A-B Erase Function

You can specify a portion within a track and erase the portion with ease. You can shift the desired portion by frame*, minute or second intervals.

This function is convenient to erase the unnecessary parts recorded from satellite broadcast or radio programs.

* 1 frame is 1/86 second.

Example: Erasing a portion of track 2

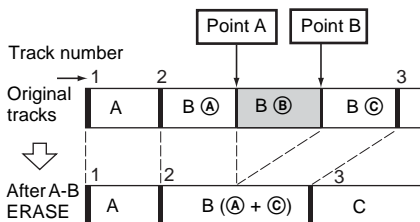

- 1** Set to MD in CD MD select switch.
- 2** Press **MENU/NO**.
- 3** Press **◀◀** or **▶▶** repeatedly (or turn **AMS**) until “A-B Erase?” appears, then press **YES** (or **AMS**).
Playback starts.
- 4** Press **◀◀** or **▶▶** repeatedly (or turn **AMS**) until the desired track number appears.
- 5** While monitoring the sound, press **YES** (or **AMS**) at the starting point of the portion to be erased (point A).
“—Rehearsal—” and “Point A ok?” appear alternately while the deck repeats a few seconds of a portion before point A.

6 Press YES (or AMS) if point A is correct.

“Point B set” appears and playback for setting the ending point of the portion to be erased (point B) starts.

If the point A is incorrect, press ◀◀ or ▶▶ repeatedly to flash minute, second, or frame indication, then press ◀◀ or ▶▶ (or turn AMS).

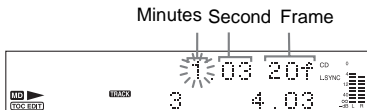

You can shift the point by 1/86 second (1 frame) intervals.*

* You can shift the point by 2-frame intervals (in Monaural mode and LP2 stereo mode) or by 4-frame intervals (in LP4 stereo mode).

7 Continue playback until the deck reaches point B, then press YES (or AMS).

“A-B Ers” and “Point B ok?” appear alternately and the deck repeats a portion of the few seconds before point A and after point B successively.

8 Press YES (or AMS) if point B is correct.

“Complete!” appears for a few seconds and the portion between point A and B is erased. Playback starts from the beginning of the track.

If the point B is incorrect, press ◀◀ or ▶▶ repeatedly to find the ending point of the portion to be erased (point B) while monitoring the sound, then press YES (or AMS).

You can shift the point by 1/86 second (1 frame) intervals.*

* You can shift the point by 2-frame intervals (in Monaural mode and LP2 stereo mode) or by 4-frame intervals (in LP4 stereo mode).

Moving recorded tracks

— Move Function

You can use this function to change the order of any track on the disc. When you move tracks, the tracks are automatically renumbered.

Example: Moving track 3 to position 2

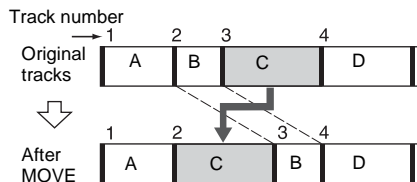

- 1 Set to MD in CD MD select switch.
- 2 Press MENU/NO.
- 3 Press ◀◀ or ▶▶ repeatedly (or turn AMS) until “Move?” appears, then press YES (or AMS).
Playback starts.
- 4 Press ◀◀ or ▶▶ repeatedly (or turn AMS) until the desired track number to move appears, then press YES (or AMS).
- 5 Press ◀◀ or ▶▶ repeatedly (or turn AMS) until the new track position appears.

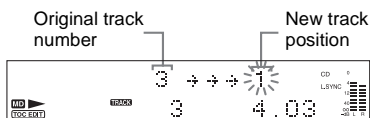

6 Press YES (or AMS).

“Complete!” appears for a few seconds and the moved track starts playing.

Note

When you move a track to a track number that is registered into a group, the moved track is re-registered into the group. In addition, if you move a track that is registered into a group to a track number that is not registered into a group, the group registration of the moved track is released. However, when the Group Function is on, you can only move tracks within the selected group.

Combining recorded tracks

— Combine Function

You can use this function to combine 2 tracks into a single track. The total number of tracks decreases by one and all tracks following the combined ones are renumbered.

Example: Combining track 3 to track 1

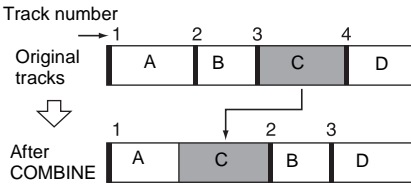

Example: Combining track 1 to track 4

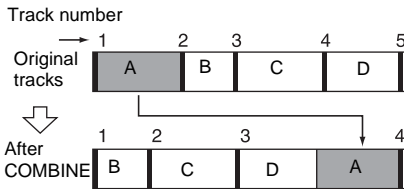

- 1 Set to MD in CD MD select switch.
- 2 Press MENU/NO.
- 3 Press **◀◀** or **▶▶** repeatedly (or turn AMS) until “Combine?” appears, then press YES (or AMS).
Playback starts.
- 4 Press **◀◀** or **▶▶** repeatedly (or turn AMS) until the first track number of the two to be combined appears, then press YES (or AMS).
For example, to combine track 1 to 4, select 4.

- 5 Press **◀◀** or **▶▶** repeatedly (or turn AMS) until the second track number of the two to be combined appears.

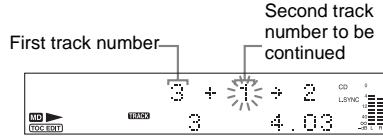

- 6 Press YES (or AMS).

“Complete!” appears for a few seconds.
Playback of the track starts.

Notes

- When you combine two tracks that are registered into different groups, the second track is reregistered into the group containing the first track. In addition, if you combine a track that is registered to a group with a track that is not registered to a group, the second track takes the same registration setting as the first track. However, when the Group Function is on, you can only combine tracks within the selected group.
- Tracks recorded in different recording modes (stereo, LP2, LP4 or MONO) cannot be combined.
- If both of the combined tracks have track titles, the title of the second track is erased.

Dividing recorded tracks

— Divide Function

You can use this function to mark track numbers after recording. You can also use this function when recording from tapes or radio programs and track numbers are not marked automatically, and want to mark tracks. The total number of tracks increases by one and all the tracks following the divided ones are renumbered.

Example: Dividing track 2 into two tracks

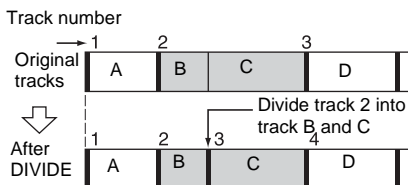

- 1** Set to MD in CD MD select switch.
- 2** Press MENU/NO.
- 3** Press ◀◀ or ▶▶ repeatedly (or turn AMS) until “Divide?” appears, then press YES (or AMS).
Playback starts.
- 4** Press ◀◀ or ▶▶ repeatedly (or turn AMS) until the desired track number to divide appears.
- 5** While monitoring the sound, press YES (or AMS) at the point to be divided.
“—Rehearsal—” appears and the portion to be divided is played repeatedly.
- 6** Press YES (or AMS) again if the point to be divided is correct.
“Complete!” appears for a few seconds and the newly created track starts playing.

If the point to be divided is incorrect, press ◀◀ or ▶▶ repeatedly to flash minute, second, or frame indication, then press ◀◀◀ or ▶▶▶ (or turn AMS).



You can shift the point by 1/86 second (1 frame) intervals.*

* You can shift the point by 2-frame intervals (in Monaural mode and LP2 stereo mode) or by 4-frame intervals (in LP4 stereo mode).

Note

If you divide a labeled track (page 32) into two tracks, only the first track retains the track title.

Example:

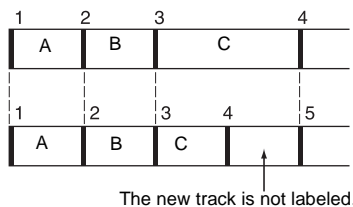

Undoing the last edit

— Undo Function

You can use this function to cancel the last edit and restore the contents of the MD to the condition before the edit.

Note, however, that you cannot undo the edit if you do any of the following after the edit:

- Do another edit.
- Do the recording procedure.
- Update the TOC by turning off the deck or ejecting the MD.
- Disconnect the power cord.

- 1 Press MENU/NO in stop mode.**
- 2 Press ◀◀ or ▶▶ repeatedly (or turn AMS) until “Undo?” appears.**

“Undo?” does not appear when there is no editing function that can be canceled.

- 3 Press YES (or AMS).**

Following message appears depending on the last edit.

Editing	Message
Labeling discs or tracks	Name Undo?
Erasing the titles	
Creating a new group	Group Undo?
Releasing a group	
Releasing all groups	
Deleting a portion of a track	Erase Undo?
Deleting a track	
Deleting all the tracks	
Moving tracks	Move Undo?
Dividing a track	Divide Undo?
Combining tracks	Combin Undo?

- 4 Press YES (or AMS) again.**

Changing the recorded level after recording

— S.F Edit Function

You can change the volume of recorded tracks. The original track is recorded over at the new recording level. When changing the recording level, you can select Fade-in Recording to gradually increase the signal level at the start of recording, or Fade-out Recording to gradually decrease the signal level at the end of the recording.

Changing the overall recording level

- 1 Set to MD in CD MD select switch.**
- 2 Press MENU/NO.**
- 3 Press ◀◀ or ▶▶ repeatedly (or turn AMS) until “S.F Edit?” appears, then press YES (or AMS).**
- 4 Press ◀◀ or ▶▶ repeatedly (or turn AMS) until “Tr Level?” appears, then press YES (or AMS).**
Playback starts.
- 5 Press ◀◀ or ▶▶ repeatedly (or turn AMS) until the track number you want to change the recording level appears, then press YES (or AMS).**
“Level 0dB” appears.
- 6 While monitoring the sound, press ◀◀ or ▶▶ repeatedly (or turn AMS) to change the recorded level.**

The recording level can be changed from -12 dB to +12 dB, in 2 dB steps. Change to the optimum level while making sure that “OVER” does not appear in the display at the loudest portion.

Adjust the level so as not to light up “OVER”.



continued

7 Press YES (or AMS).

“Edit OK?” appears.

8 Press YES (or AMS) again.

The deck starts recording over the existing track.

“S.F Edit ** %” appears while the track is being recorded. An amount of time that is roughly equal to or longer than the playback time of the track is required when recording over the track. When the recording finishes, “Complete!” appears.

8 Press YES (or AMS) again.

The deck starts recording over the existing track.

“S.F Edit ** %” appears while the track is being recorded. When the recording finishes, “Complete!” appears.

To cancel the operation

Press MENU/NO during step 3 through 7. After pressing YES (or AMS) in step 8 to start recording, you cannot interrupt the operation.

Notes

- You cannot change the recording level of the tracks recorded in MDLP mode.
- Repeatedly changing the recording level results in poor sound quality.
- The recording level will not return to the exact original level once the recording level has been changed even if it returned to the original level.
- You cannot undo the S.F Edit Function even if you use the Undo Function.

**Fade-in and Fade-out
Recording**

1 Set to MD in CD MD select switch.

2 Press MENU/NO.

3 Press I◀◀ or ▶▶I repeatedly (or turn AMS) until “S.F Edit?” appears, then press YES (or AMS).

4 Press I◀◀ or ▶▶I repeatedly (or turn AMS) until “Fade In?” or “Fade Out?” appears, then press YES (or AMS).

Playback starts.

5 Press I◀◀ or ▶▶I repeatedly (or turn AMS) until the track number you want to change the recording level appears, then press YES (or AMS).

“Time5.0s” appears.

6 While monitoring the sound, press I◀◀ or ▶▶I repeatedly (or turn AMS) to change the Fade-in or Fade-out recording time.

The deck plays the portion that will be recorded over using Fade-in or Fade-out Recording. You can set the time at any value between 1.0 second and 15.0 seconds, in 0.1 second steps. You cannot set the time longer than the track.

7 Press YES (or AMS).

“Edit OK?” appears.

Problems and remedies

If you experience any of the following difficulties while using the deck, use this troubleshooting guide to help you remedy the problem.

CD player section

The player does not start playing.

- Insert a CD.
- Place the CD properly.
- Clean the CD.
- Remove the CD, then leave the deck turned on for about an hour until the moisture evaporates.

MD deck section

The deck does not operate or operates poorly.

- The MD may be damaged (“Read Error” appears). Take the MD out and insert it again. If “Read Error” remains, replace the MD.

The deck does not play back.

- Remove the MD, then leave the deck in a warm place for several hours until the moisture evaporates.
- Press **I/⏻** to turn the deck on.
- Slide the MD into the disc slot with the label side up and the arrow pointing towards the opening.
- Replace the disc with one that has been recorded.

The deck does not record.

- The MD is record-protected (“Protected” and “C11” alternate). Remove the MD and slide the tab to close the slot (page 20).
- Connect the optional component properly (page 7).
- Press **INPUT** repeatedly to select the recording source correctly.
- Readjust the recording level (page 25).
- A premastered MD is inserted. Replace with a recordable MD.
- There is not enough time left on the MD. Replace it with another recordable MD with fewer recorded tracks, or erase unnecessary tracks.
- There has been a power failure or the AC power cord has been disconnected during recording. Data recorded to that point may be lost. Repeat the recording procedure.

The deck does not edit.

- Press **PLAY MODE** repeatedly until both “PROGRAM” and “SHUFFLE” disappear.
- Remove the MD and slide the tab to close the slot (page 20).

The sound has a lot of static.

- Strong magnetism from a television or a similar device is interfering with operations. Move the deck away from the source of strong magnetism.

The three- or five letters appear.

- The Self-Diagnosis Function is on. Check the table on page 44.

Others

No sound is output.

- Make the connections properly.
- Operate the amplifier properly.
- When using the headphones, turn **PHONE LEVEL** to turn up the output level.

The remote does not function.

- Make sure that there is no obstacles between the deck and the remote.
- Point the remote at the remote sensor on the deck.
- Replace the batteries in the remote.

After you've attempted the prescribed remedies

If the deck still does not operate properly, or if other problems not described above occur, turn off the deck, then reinsert the plug into the power outlet.

If the problem persists, reset the deck as follows:

- 1 Turn off the deck and unplug the AC power cord.
- 2 Reinsert the plug into the power outlet while pressing down **I/⏻**.

Should any problem persist even after resetting the deck, consult your nearest Sony dealer.

Self-diagnosis display

This deck has a Self-diagnosis display function to let you know if there is a deck malfunction. The display shows a code made up of three or five letters and a message alternately to show you the problem. To solve the problem refer to the following list. If any problem persists, consult your nearest Sony dealer.

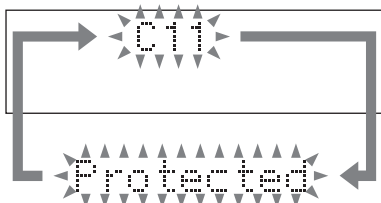

C11/Protected

The MD is protected against erasure.

→ Remove the MD and slide the tab to close the slot (page 20).

C12/Cannot Copy

You tried to record a CD with a format that the deck does not support, such as a CD-ROM or MD data.

→ Replace the playable disc.

C13/REC Error

Recording could not be performed properly.

→ Move the deck to a stable place, and start recording over from the beginning.

The MD is dirty or scratched, or the MD does not meet the standards.

→ Replace the MD and start recording over from the beginning.

C13/Read Error

The MD deck cannot read the disc information properly.

→ Remove the MD once, then insert it again.

C14/TOC Error

The MD deck cannot read the disc information properly.

→ Replace the MD.

→ Erase all the recorded contents of the MD using the All Erase Function (page 37).

C41/Cannot Copy

The digitally dubbed material cannot be recorded digitally (page 47).

C71/Din Unlock

The digitally dubbed material cannot be recorded digitally (page 47).

A moment's lighting is due to the signals of the digital program being recorded. This does not affect the recorded material.

The digital optical cable is disconnected, or the power of the connected component is turned off while recording the digital audio from the component connected to the DIGITAL OPTICAL IN jack.

→ Connect the digital optical cable, or turn on the power of the connected component.

E0001/MEMORY NG

The component has internal problem.

→ Consult your nearest Sony dealer.

E0101/LASER NG

There is a problem with the laser pickup.

→ The laser pickup may be damaged. Consult your nearest Sony dealer.

E0201/LOADING NG

There is a problem with the loading.

→ The loading may be failed. Consult your nearest Sony dealer.

Messages

One of the following messages may appear or flash in the display during operation.

Blank Disc

The inserted recordable MD is new, or all tracks on the MD have been erased.

Cannot Copy

An attempt was made to make a second copy from a digitally dubbed MD (page 47).

Cannot Edit

- You tried to edit in Program or Shuffle Play mode.
- The track is recorded in MDLP mode.
- The MD is record-protected.

CD Error!

An operational error has occurred in the CD player section. Wait a few seconds, and then try the operation again.

Disc Full!

The MD is full (see System Limitations on page 47).

Edit NOW

You pressed I/⏪ while in S.F Edit (changing the recording level after recording, Fade-in, Fade-out) mode.

If you turn off the deck while in S.F Edit mode, any changes that you have made will not be made properly. Finish the changes and leave S.F Edit mode before turning off the deck.

Impossible

You tried to make an impossible editing operation (page 30).

Incomplete!

Adjustment of the recording level after recording or Fade-in and Fade-out procedures have failed since the deck was either subject to vibration or there is a damaged or dirty disc in the tray.

Initialize (flashing when you turn on the deck)

The power was off for a long time, so the deck is initializing itself.

Name Full!

The title capacity of the MD has reached its limit (about 1,700 characters).

No Change

While attempting to change the recording level after recording, you pressed YES (or AMS) without actually changing the recording level, so no change was made.

—No Disc—

There is no disc in the MD deck, or no disc in the CD player.

No Name

The disc or track has not been labeled.

Premastered

An attempt was made to record on the premastered MD.

Retry

The deck is retrying reading data from the CD during High-Speed CD-MD Synchro Recording (page 29).

Step Full!

You tried to program more tracks (steps).

TrProtected

Tracks and other data that have been checked out on Net MD equipment are protected, so you cannot use some of the MD editing functions.

Additional Information

Precautions

On safety

- AC power cord must be changed only at the qualified service shop.
- The unit is not disconnected from the AC power source (mains) as long as it is connected to the wall outlet, even if the unit itself has been turned off.

On placement

- Do not place the deck in an inclined position.
- Do not place the deck in locations where it is;
 - Extremely hot or cold
 - Dusty or dirty
 - Very humid
 - Subject to vibrations
 - Subject to direct sunlight.
 - near a Tuner, TV set or Video deck.

On condensation in the deck

If the deck is brought directly from a cold to a warm location, or is placed in a very damp room, moisture may condense on the lenses inside the deck. Should this occur, the deck may not operate properly. In this case, remove the CD or MD and leave the deck turned on for about an hour until the moisture evaporates.

Notes on MDs

- Do not open the shutter to expose the MD. Close the shutter immediately if the shutter opens.
- Affix the label supplied with the disc only to the specified label indentation. Do not affix the label around the shutter or in other locations. Note that the shape of the indentation depends on the disc.

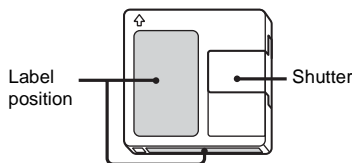

- Wipe the disc cartridge with a dry cloth to remove dirt.
- Do not expose the MD to direct sunlight or heat sources such as hot air ducts, nor leave it in a car parked in direct sunlight.

Notes on CDs

- Before playing, clean the disc with a cleaning cloth. Wipe the disc from the center out.
- Do not use solvents such as benzene, thinner, commercially available cleaners or anti-static spray intended for vinyl LPs.
- Do not expose the disc to direct sunlight or heat sources such as hot air ducts, nor leave it in a car parked in direct sunlight.
- Do not use discs encircled with a protection ring. This may cause a malfunction to the deck.
- When using discs that have glue or similar tacky substance on the label side of the disc or that used a special ink when the label was printed, there is a chance that the disc or label may become attached to parts inside this unit. When this occurs, it may not be possible to remove the disc, and may also cause this unit to malfunction. Be sure to check that the label side of the disc is not sticky before using. The following types of disc should not be used:
 - Rental or used discs with attached seals where the glue extends beyond the seal. The perimeter of the seal on the disc is tacky.
 - Discs that have labels printed using a special ink that feels tacky when touched.
- CDs with non-standard shapes (e.g., heart, square, star) cannot be played on this unit. Attempting to do so may damage the unit. Do not use such CDs.

Cleaning the cabinet

Clean the cabinet, panel and controls with a soft cloth slightly moistened with mild detergent solution. Do not use any type of abrasive pad, scouring powder or solvent such as thinner, benzene or alcohol.

System limitations of MDs

The recording system in your MD deck has the limitations described below.

Note, however, that these limitations are due to the inherent nature of the MD recording system itself, not to mechanical causes.

“Disc Full!” appears before the MD has reached the maximum recording time

When 255 tracks have been recorded on the MD, “Disc Full!” appears regardless of the total recorded time. More than 255 tracks cannot be recorded on the MD. To continue recording, erase unnecessary tracks or use another recordable MD.

“Disc Full!” appears before the maximum number of tracks (255) is reached

Fluctuations in emphasis within tracks are sometimes interpreted as track intervals, increasing the track count and causing “Disc Full!” to appear.

“Group Full!” appears in the display

- When the Group Function is on, “Group Full!” may be displayed if editing is performed. This means there are insufficient characters for group management. Delete any unnecessary disc titles, group titles or other characters.
- Even when the Group Function is off, the group management information is updated automatically when Move, Divide and other editing operations are performed, so “Group Full!” may be displayed.

The remaining recording time does not increase even after erasing numerous short tracks

Tracks shorter than 12 seconds* are not counted, so erasing them may not increase the recording time.

* During Stereo recording.

In Monaural or LP2 stereo mode: about 24 seconds
In LP4 stereo mode: about 48 seconds.

“Impossible” appears when you use A-B Erase Function or Combine Function

This happens when you have edited the same track many times. This is due to a technical limitation of the MD deck and is not a mechanical error.

The total recorded time and the remaining time on the MD do not add up to the maximum recording time

Recording is done in minimum units of 2 seconds* each, no matter how short the material. The recorded contents may be shorter than the maximum recording capacity. Disc space may also be reduced by scratches.

* During Stereo recording.

In Monaural or LP2 stereo mode: about 4 seconds

In LP4 stereo mode: about 8 seconds.

The sound may drop-out while searching the edited tracks

Tracks created through editing may exhibit sound dropout during searching because high-speed playback requires time to search for the position on the disc when the tracks are not in order.

Track numbers cannot be marked

Even in the Level Synchro Recording, the track numbers may not be marked at the beginning of the track:

- if the input signal is below a certain fixed level for less than 2 seconds between tracks.
- if the input signal is below a certain fixed level for more than 2 seconds in the middle of the track.
- if you record a track that is 4 seconds or less*.

* During Stereo, Monaural or LP2 stereo recording mode (In LP4 stereo recording mode: 8 seconds or less).

Extra tracks are created

When there is a long silence between CD tracks, an extra track may be created.

The number of tracks on the CD and the recorded MD is different

When there are short tracks on the CD, track numbers may not be marked for these tracks, and the number of tracks recorded on the MD may differ from that of the CD.

Guide to the Serial Copy Management System

Digital audio components, such as CDs, MDs, and DATs let you copy music easily with high quality by processing music as a digital signal.

To protect the copyrighted music programs, this deck uses the Serial Copy Management System that allows you to make only a single copy of a digitally recorded source through digital-to-digital connections.

You can make only a first generation copy* through a digital-to-digital connection.

For example:

- 1 You cannot make a second digital copy via the digital input jack onto another DAT or MD deck from the first-generation copy recorded by the deck digitally.
- 2 You can make a copy of a digital signal from a digitally recorded analogue sound programme (for example, an analogue record or a music cassette tape) or from a digital satellite broadcast programme, but you cannot make a second copy.

* A first-generation copy means a digital recording of a digital signal made on digital audio equipment. For example, if you record from this deck's CD player to the MD deck, you make a first-generation copy.

Specifications

CD player section

System	Compact Disc digital audio system
Laser	Semiconductor laser ($\lambda=780$ nm)
Frequency response	20 Hz – 20 kHz (± 0.5 dB)
Wow and flutter	Below measureable limit ($\pm 0.001\%$ W.PEAK)

MD deck section

System	MiniDisc digital audio system
Disc	MiniDisc
Laser	Semiconductor laser ($\lambda=780$ nm) Emission duration: continuous
Sampling frequency	44.1 kHz
Frequency response	20 Hz – 20 kHz (± 0.5 dB)

Inputs

	Jack type	Input impedance	Rated input	Minimum input
ANALOG IN	Pin jack	47 kilohms	500 mVrms	250 mVrms
DIGITAL OPTICAL IN	Squqre optical connector jack	Optical wave length: 660 nm	–	–

Outputs

	Jack type	Rated output	Load impedance
ANALOG OUT	Pin jack	2 Vrms (at 47 kilohms)	Over 10 kilohms
DIGITAL OPTICAL OUT	Squqre optical connector jack	-18 dBm	Optical wave length: 660 nm
PHONES	Stereo phone jack	10 mW	32 ohms

General

Power requirements	U.S.A. and Canada Europe	120 V AC, 60 Hz 230 V AC, 50/60 Hz
Power consumption		19 watts Less than 1 watt (at the power saving mode)
Dimensions (w/h/d) incl. projecting parts and controls		Approx. 430 × 108 × 399 mm
Mass		Approx. 5.4 kg

Supplied accessories

See page 7.

US and foreign patents licensed from Dolby Laboratories.

Design and specifications are subject to change without notice.

List of button locations and reference pages

How to use this page

Use this page to find the location of buttons and other parts of the deck that are mentioned in the text.

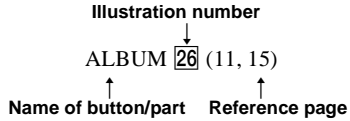

Main unit

ALPHABETICAL ORDER

A - I

- ALBUM **26** (11, 15)
- AMS **21** **25** (10, 11, 12, 13, 14, 15, 17, 24, 25, 26, 33, 34, 36, 38, 39, 40, 41, 42)
- CD SYNCHRO NORMAL/HIGH **4** (20)
- CLEAR **22** (15)
- Disc tray **3** (9)
- DISPLAY **19** (18)
- Display window **24** (18)
- EJECT **6** (12)
- GROUP ON/OFF **9** (15, 21, 22, 33, 34, 35)
- GROUP SKIP **10** (21, 22, 34, 35)
- INPUT **11** (21, 22, 25, 26)

J - Z

- MD slot **5** (11)
- MDLP indicator **7** (29)
- MENU/NO **23** (17, 24, 25, 26, 30, 33, 34, 35, 36, 37, 38, 39, 40, 41, 42)
- OPEN/CLOSE **2** (9, 10)
- PHONES jack **32**
- PHONE LEVEL **33** (43)
- PLAY MODE **17** **27** (9, 10, 12, 14, 30)
- REC LEVEL **13** (25)
- REC MODE **8** (20, 21, 23, 29)
- REC ● **12** (21, 25, 26)
- STANDBY indicator **34** (8)
- TIME **18** **28** (18)
- YES **20** (14, 17, 24, 25, 26, 33, 34, 35, 36, 37, 38, 39, 40, 41, 42)

BUTTON DESCRIPTIONS

- I/⏻ (power/standby) **1** (8, 20, 30)
- ▶ (play) **14** **29** (9, 11, 12, 15, 20, 27)
- ⏸ (pause) **16** **30** (10, 12)
- (stop) **15** **31** (10, 12, 21, 22, 23, 27)

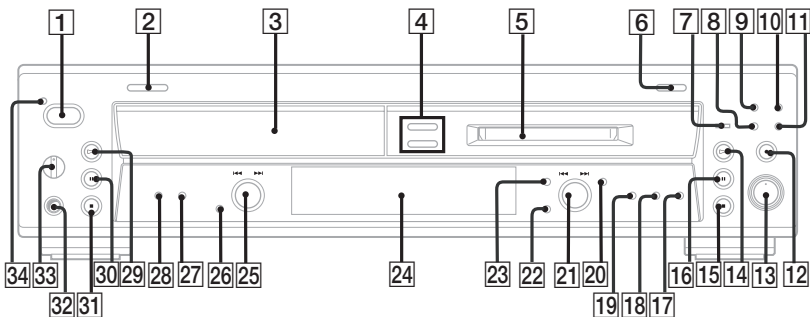

Remote control

ALPHABETICAL ORDER

A - M

- ALBUM/GROUP +/- **14** (15, 21, 22, 33, 34, 35)
- CD MD select **28** (9, 10, 12, 13, 14, 15, 17, 18, 24, 25, 27, 32, 35, 36, 37, 38, 39, 40, 41, 42)
- CD SYNCHRO NORMAL/
HIGH **21** (20)
- CLEAR **8** (15)
- DISPLAY **25** (18)
- FADER **22** (28)
- GROUP ON/OFF **23** (15, 21, 22, 33, 34, 35)
- INPUT **27** (21, 22, 25, 26)
- MENU/NO **24** (17, 24, 25, 26, 30, 33, 34, 35, 36, 37, 38, 39, 40, 41, 42)
- MUSIC SYNC **9** (27)

N - Z

- NAME EDIT/SELECT **6** (33)
- number buttons **7** (13, 15, 33)
- PLAY MODE **3** (9, 10, 12, 14, 30)
- REC MODE **2** (20, 21, 23, 29)
- REC-IT **10** (27)
- REPEAT **16** (14)
- SCROLL **26** (18, 34)
- SLEEP **15** (16)
- T.REC **13** (23)
- TIME **4** (18)
- YES **5** (14, 17, 24, 25, 26, 33, 34, 35, 36, 37, 38, 39, 40, 41, 42)

BUTTON DESCRIPTIONS

- ⏮ / ⏭** (skip) **18** (10, 11, 12, 13, 14, 15, 17, 24, 25, 26, 33, 34, 36, 37, 38, 39, 40, 41, 42)
- I/O** (power/standby) **1** (8, 20, 30)
- ⏪ / ⏩** (search) **17** (10, 12, 33)
- ▶** (play) **20** (9, 11, 12, 15, 20, 27)
- ⏸** (pause) **11** (10, 12)
- (stop) **12** (10, 12, 21, 22, 23, 27)
- (record) **19** (23)

